



THE CORPORATION OF THE TOWN OF GODERICH

BY-LAW NO. 22 OF 2016

**BEING A BY-LAW TO AUTHORIZE THE ADOPTION OF AN
UPDATED HURON COUNTY UNIVERSAL DESIGN AND ACCESSIBILITY
GUIDELINE FOR SITE PLAN CONTROL AND, REPEAL BY-LAW 77 OF 2012,
BEING A BY-LAW WHICH AUTHORIZED THE ADOPTION OF A
UNIVERSAL DESIGN AND ACCESSIBILITY GUIDELINE FOR SITE PLAN
CONTROL FOR THE CORPORATION OF THE TOWN OF GODERICH**

WHEREAS the Province of Ontario released Design of Public Spaces Standards under the Accessibility for Ontarians with Disability Act, 2005;

AND WHEREAS the Huron County Accessibility Advisory Committee has updated the Huron County Universal Design and Accessibility Site Plan Guidelines to incorporate the Design of Public Spaces Standards;

AND WHEREAS the Council of the Corporation of the County of Huron has endorsed the updated Huron County Universal Design and Accessibility Site Plan Guidelines in December, 2015;

AND WHEREAS the Town of Goderich adopted the 2008 Huron County Universal Design and Accessibility Site Plan Control Guidelines By-law 77 of 2012 on July 16, 2012;

AND WHEREAS Section 2 (h.1) of the Planning Act establishes the accessibility for persons with disabilities to all facilities, services, and matters to which the Planning Act applies as a provincial interest;

AND WHEREAS Section 41(4)(f) of the Planning Act, R.S.O. 1990, establishes no person may undertake any development until they have submitted drawings which are sufficient to display facilities designed to have regard for accessibility for persons with disabilities;

AND WHEREAS it is deemed expedient to adopt the 2016 Huron County Universal Design and Accessibility Site Plan Control Guidelines and repeal By-law 77 of 2012 adopting the 2008 Huron County Universal Design and Accessibility Site Plan Control Guidelines;

NOW, THEREFORE, THE COUNCIL OF THE CORPORATION OF THE TOWN OF GODERICH ENACTS AS FOLLOWS:

1. That the Town of Goderich hereby adopts the 2016 Huron County Universal Design and Accessibility Site Plan Control Guidelines;
2. That By-law 77 of 2012, being a By-law to adopt the 2008 Huron County Universal Design and Accessibility Site Plan Control Guidelines, be and is hereby repealed in its entirety.

READ A FIRST, SECOND AND THIRD TIME AND FINALLY PASSED THIS 8th DAY OF FEBRUARY, 2016.

MAYOR, Kevin Morrison

CLERK, Dwayne Evans

Universal Design and Accessibility Guideline for Site Plan Control



2016 Edition

Huron County Accessibility Advisory Committee
1 Court House Square
Goderich, ON
N7A 1M2
519-524-8394
www.huroncounty.ca



Table of Contents

Introduction	3
Acknowledgements	5
Enactment.....	6
Definitions	7
List of Figures and Tables.....	10
Section 1 Site Plan Control Accessible Design Standards	11
1.1 Exterior Paths of Travel.....	12
1.2 Ramps.....	14
1.3 Curb Ramps	19
1.4 Stairs.....	21
1.5 Off-Street Parking	24
1.6 Passenger Loading Zones	28
1.7 Landscaping Materials and Plantings	29
1.8 Street Furniture	30
1.9 Lighting, Texture & Colour, Materials & Finishes	31
Bibliography	32
Section 2 Accessible Design Checklist for Site Plans	33

Introduction

March, 2015

Dear User & Partner in Accessibility,

Most persons with disabilities see themselves as independent individuals with the ability to control all facets of their lives. The attitudes of non-disabled Ontarians are also evolving to be more consistent with the views and realities of persons with disabilities. As a result, Ontarians with disabilities are no longer viewed as 'exceptions' whose needs must be met through segregated programs. They are now seen as fellow citizens, who share the belief that we have a responsibility to one another and that each of us has something of value to contribute. Ontarians are working together to build a prosperous, caring and inclusive society – one in which everyone has the opportunity to lead a full, rich and meaningful life.

While much progress has been made by government to develop legislation and direct resources towards a vision of full inclusion and a barrier-free society, the reality today is that persons with disabilities continue to face barriers.

As of 2012, 15.4% of Ontarians have a disability, and 37% of those people are aged 65 and older (Statistics Canada C. , 2012). The rate of disability increases as age increases. As the Ontario population is aging, providing our communities and their residents with barrier free support systems and services is critical to ensuring continued independent living for everyone. Investment, co-operation, and leadership are required by both government and private enterprise in order to achieve this goal.

A multitude of emerging opportunities exist to reduce barriers that prevent many people, but especially our disabled population, from enjoying full inclusion.

A key area where Municipalities have direct influence over improving barrier-free access for persons with disabilities is through the development process. As properties are being developed through new construction or redevelopment, there is a significant opportunity and obligation for Municipalities to ensure that facilities being constructed are accessible.

The purpose of the Ontarians with Disabilities Act, and more recently the Accessibility for Ontarians with Disabilities Act, is to improve access and opportunities for persons with disabilities. In 2006, the provincial government made several changes to the Planning Act to support the Ontarians with Disabilities Act. The province established that planning approval authorities shall have regard to accessibility for persons with disabilities in their land use planning and development decisions.

The 2014 Provincial Policy Statement further supports improving accessibility for persons with disabilities and older persons by identifying, preventing, and removing land use barriers which restrict their full participation in society.

The Ontarians with Disabilities Act also specifies that a municipal accessibility advisory committee may request to review site plans and drawings described in Section 41 [Site Plan Control] of the Planning Act.

As of 2011, the median age of Huron County's population was 45.1, with 43% of the population over 50 years of age (Statistics Canada N. , 2011). This is compared to 2006 statistics where the median age was 42, and 38% of the population was over 50 years of age (Statistics Canada C. , 2006). Considering that 15.4% of Ontarians have a disability, and 37% of those are over 65 years of age; it is critical to ensure that properties are designed to be accessible in Huron County (Statistics Canada C. , 2012).

In Huron County, the decision was made to establish an accessibility advisory committee at the County level, rather than having each municipality establishing their own committee. The Huron County Accessibility Advisory Committee was established in 2005 and meets regularly to provide advice to Huron County Council on matters related to accessibility and to assist municipalities in making their facilities, by-laws, and services accessible to everyone.

The Huron County Accessibility Advisory Committee is aware of its authority under the Ontarians with Disabilities Act and the Planning Act to request to review site plans and drawings from municipalities. The HCAAC Committee is equally aware, that for every municipality in Huron County to supply each private site plan to a County Committee is cumbersome and may not facilitate municipal site plan control approvals in a timely fashion.

That being said, the HCAAC committee wants to assist municipalities in Huron County while fulfilling their obligation to ensure that developments being approved under the site plan control process are accessible and have regard for persons with disabilities.

In the interest of assisting municipalities in Huron County, the HCAAC committee has prepared this document, outlining standards for accessibility that can be adopted by municipal councils and implemented locally through the site plan control approval process.

The HCAAC committee firmly believes that it is important to implement the same standards of accessibility throughout the province and region; as such, the 2008 guideline has been updated to be consistent with the Design of Public Spaces Standard, a standard under the Accessibility for Ontarians with Disabilities Act, 2005.

The Huron County Accessibility Advisory Committee looks forward to continuing to work with the relevant standards established in the Public Spaces Regulation released under the AODA in 2013, and with municipal councils and staff to implement the Huron County Universal Design and Accessibility Guidelines for Site Plan Control.

Sincerely,
Members of the Huron County Accessibly Advisory Committee, 2015

Acknowledgements

The Huron County Universal Design and Accessibility Guidelines for Site Plan Control have been developed relying primarily on incorporating relevant sections of the Design of Public Spaces Standards (Accessibility Standards for the Built Environment), part IV.1 of the Integrated Accessibility Standards 191/11, a regulation of Accessibility for Ontarians with Disabilities Act and from the standards that were developed by the City of London in their Facility Accessibility Design Standards.



The Committee would like to acknowledge the City of London for its excellent work in developing the Facility Accessibility Design Standards and for their generosity in sharing those standards with the Huron County Accessibility Committee, the Corporation of the County of Huron and its member Municipalities.



If you have questions or comments on the Huron County Accessibility Guideline for Site Plan Control please contact:

Huron County Accessibility Advisory Committee
c/o The Corporation of the County of Huron
1 Court House Square
Goderich, ON N7A 1M2
519-524-8394



Conflict between this Guideline and Design of Public Spaces Standard

In the event where there is conflicting technical requirements as set out between this guideline and the Design of Public Spaces Standard, the regulations of the AODA Design of Public Spaces Standard shall supersede.

Enactment

WHEREAS the Huron County Accessibility Advisory Committee has developed the Huron County Universal Design and Accessibility Site Plan Guidelines;

AND WHEREAS, the Council of the Corporation of the County of Huron has endorsed the Huron County Universal Design and Accessibility Site Plan Guidelines in December 2015;

AND WHEREAS, Section 2 (h.1) of the Planning Act, establishes the accessibility for persons with disabilities to all facilities, services, and matters to which the Planning Act applies as a provincial interest.

AND WHEREAS Section 41(4)(f) of the Planning Act, R. S. O. 1990, establishes no person may undertake any development until they have submitted drawings which are sufficient to display (f) facilities designed to have regard for accessibility for person with disabilities.

The Council of the Corporation of the Town of Goderich now hereby repeals the 2008 Huron County Universal Design and Accessibility Site Plan Control Guidelines, and enacts the 2016 edition of the Huron County Universal Design and Accessibility Guidelines for Site Plan Control as the Corporation of the Town of Goderich standards to review drawings submitted under section 41 of the Planning Act against to ensure that facilities have been designed to have regard for accessibility for persons with disabilities (s. 41(2)(f) of the Planning Act).

Standards Endorsed by
Council of the Corporation of the County of Huron
December 16, 2015.

Standards Adopted by By-Law 22 of 2016
Council of the Corporation of the Town of Goderich
February 8, 2016

Definitions

Access aisle: The space between parking spaces that allows persons with disabilities to get in and out of their vehicles. They must be provided at all accessible parking spaces in off-street parking facilities.

Accessible: Describes a site, building, facility or portion thereof that complies with this guideline.

Accessible element: An element specified by the Design of Public Spaces Standard (for example, telephone, controls etc.).

Accessible route: A continuous unobstructed path connecting accessible elements and spaces of a facility. Exterior accessible routes may include parking access aisles, curb ramps, crosswalks at vehicular ways, walks, ramps and platform lifts.

Bevel: A small slope that is cut into a right angle that helps mobility devices to cross a small elevation change.

Building: A structure occupying an area greater than ten square meters, consisting of a wall, roof and floor or any of them, or a structural system serving the function thereof, including all plumbing, fixtures and service systems appurtenant thereto; or a structure occupying an area of ten square meters or less that contains plumbing, including the plumbing appurtenant thereto; plumbing not located in a structure; a sewage system; or structures designated in the Ontario Building Code.

Cross slope: The slope that is perpendicular to the direction of travel. (See running slope)

Curb ramp: A short ramp cutting through a curb or built up to a curb.

Detectable warning surfaces: A standardized surface feature built into or applied to walking surfaces or other elements to warn persons with a visual impairment of hazards on a circulation path.

Disability: Any restriction or lack of ability to perform an activity in the manner or within the range considered normal for a human being.

Egress, Means of: A continuous and unobstructed way of exit travel from any point in a facility to a public way. A means of egress comprises vertical and horizontal travel and may include intervening room spaces, doorways, hallways, corridors, passageways, balconies, ramps, stairs, enclosures, lobbies, horizontal exits, courts and yards. An accessible means of egress is one that complies with this standard and does not include stairs, steps or escalators. Areas of rescue assistance, protected lobbies or protected elevators may be included as part of an accessible means of egress.

Entrance: Any access point into a building or facility used for the purposes of entering. An entrance includes the approach walk, the vertical access leading to the entrance platform, the

entrance platform itself, vestibules (if provided), the entry door(s) or gate(s), and the hardware of the entry door(s) or gate(s).

Exterior Paths: These are sidewalks and walkways intended to provide a functional route from Point A to Point B, rather than recreational paths that are intended to provide a recreational experience.

Facility or Facilities: All or any portion of buildings, structures, site improvements, complexes, equipment, roads, walks, passageways, parks, parking lots or other real or personal property located on a site.

Guard: A safety railing used as a barrier to prevent encroachment or accidental falling from heights.

Handrail: A component which is normally grasped by hand for support at stairways and other places where needed for the safety of pedestrians.

Headroom Clearance: Refers to the area above the surface of the sidewalk/walkway. This area must be clear of any obstacle that a person may have to duck under, such as signs or tree branches.

In- line Ramp: A ramp that does not change direction.

Landing: A level area at the top and bottom, and in between sets of stairs and ramps. They provide sufficient space to turn and a place to briefly rest.

Marked crossing: A crosswalk or other identified path intended for pedestrian use in crossing a vehicular way.

Nosing Projection: The part of the run of the step which extends out past the rise (typically only by a couple inches).

Park: Land that is privately or publicly held that has been developed for multiple recreational and leisure-time uses. This land benefits the entire community and balances the demands of the public for outdoor recreational facilities and other amenities, such as pathways, picnic areas, playgrounds, water features, spaces for free play and leisure.

Ramp: A walking surface which has a running slope greater than 1:25.

Rest Area: A dedicated space on an exterior path of travel intended for public use that allows a person to stop and rest.

Running slope: The slope that is parallel to the direction of travel. (See Cross slope)

Signage: Displayed verbal, symbolic, tactile and pictorial information.

Site: A parcel of land bound by a property line or a designated portion of a public right-of-way.

Site improvement: Landscaping, paving for pedestrian and vehicular ways, outdoor lighting, and recreational facilities added to a site.

Space: A definable area (e.g. room, toilet room, hall, assembly area, entrance, storage room, alcove, courtyard or lobby).

Technically infeasible: Means (with respect to an alteration of a building or a facility), that there is little likelihood of it being accomplished, due to the following:

- Existing structural conditions would require moving or altering a load-bearing member which is an essential part of the structural frame; or
- Other existing physical or site constraints prohibit modification or addition of necessary elements, spaces or features that are in full and strict compliance with the minimum requirements for new construction.

Tactile Surface Indicators: is a system of textured ground surface indicators found on many footpaths, stairs and ramps to assist pedestrians who are blind or visually impaired. This is a key accessibility and safety feature.

Tonal Contrast: The difference between light and dark colours. The more stark the difference, the easier it is for people with poor eyesight to identify. This is a key accessibility and safety feature.

Tread: The top surface of a step or stair.

Van Accessible Signage: provides information to users on the intended use of the parking space. It does not prevent other types of vehicles from using them.

Walk: An exterior pathway with a prepared surface intended for pedestrian use, including general pedestrian areas, such as plazas and courts, within the boundary of the site.

(IAS 191/11, part IV.1)
(Accessibility for Ontarians with Disabilities Act, 2005)
(Government of Ontario, 2014)
(Facilities Accessibility Design Standards, 2007)

List of Figures and Tables

Figure 1.1 Cross Slope	13
Figure 1.2 Running Slope	13
Figure 1.3 Head Clearance	13
Figure 1.4 Design Requirements for Sidewalks and Walkways.....	14
Figure 1.5 Ramp Criteria- Ramp, Landing and Handrail	17
Figure 1.6 Handrail Dimensions	18
Figure 1.7 Horizontal Handrail Extensions and Edge Protection at Ramps.....	18
Figure 1.8 Standard Curb Ramp with Flared Sides.....	20
Figure 1.9 Tonal Contrast Tactile Walking Surface Indicators.....	20
Figure 1.10 Corner Curb Ramps	21
Figure 1.11 Stair Dimensions.....	23
Figure 1.12 Signage Design Requirements	25
Figure 1.13 Type A Parking Space with Access Aisle.....	27
Figure 1.14 Type B Parking Space with Access Aisle.....	27
Figure 1.15 Design Criteria for Access Aisles	28
Figure 1.16 Clearances at Passenger Loading Zones	29
Table 1 Minimum Number and Type of Accessible Parking Spaces	26
Table 2 Examples of Accessible Parking Requirements (assuming in odd number cases, Type B is preferred).....	26

Section 1 Site Plan Control Accessible Design Standards

1.1 Exterior Paths of Travel

(Design of Public Spaces Standard, AODA)

Rationale

When we leave our homes, we depend on these paths to take us to everything our communities have to offer. These paths are important links between places to work, travel, shop, and play for everyone in our communities. Pathways are to be designed in accordance with accessibility design standards in order to ensure persons travelling using a mobility aid or pushing a stroller can travel safely, and reach their intended destination without barriers.

Application

A minimum of one accessible route complying with this section shall be provided within the boundary of the site from accessible parking spaces, passenger-loading zones, and public streets or sidewalks to the accessible facility entrance they serve. The accessible route shall, to the maximum extent feasible, coincide with the route for the general public.

Design Requirements

This section applies to newly constructed or redeveloped exterior paths of travel that are outdoor sidewalks or walkways designed and constructed for pedestrian travel and are intended to serve a functional purpose and not to provide a recreational experience. *All exterior paths must meet the following:*

- The minimum clear width of an exterior path shall be 1,500 mm
 - Except at a turning space where the exterior path connects with a curb ramp and can be reduced to a minimum of 1,200 mm (See Figure 1.4);
- Head clearance room less than 2,100 mm over a portion of the exterior path must have a barrier (eg. railing) with a leading edge around the obstructing object that is cane detectable (See Figure 1.3)
- Surface must be firm, stable and slip resistant;
- Have a maximum running slope of 1:20 (5%) (Refer to Figure 1.2);
 - But where the exterior path is a sidewalk, it can have a slope greater than 1:20, but no steeper than the adjacent roadway
- Have a maximum cross slope of 1:20 (5%) where the surface is hard (asphalt) (Refer to Figure 1.1);
 - For all other cases, the maximum cross slope is 1:10
- All portions of an accessible route shall be equipped to provide a minimum level of illumination of 50lux (4.6 ft-candles).
- Sidewalk or walkway entrances must have a minimum clear opening of 850 mm (Refer to Figure 1.4);
 - Should be clear of any obstructions (eg. handles, locks or hinges)

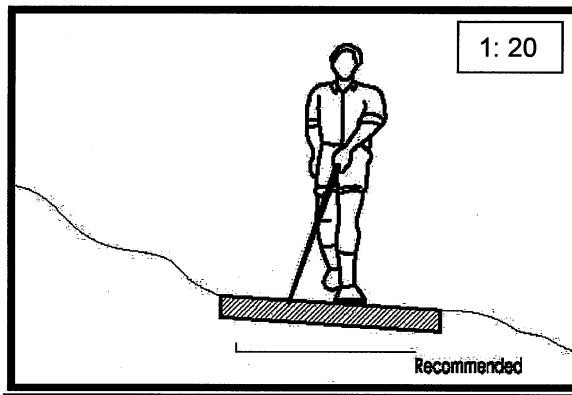

Figure 1.1 Cross Slope (Global Alliance on Accessible Technologies and Environments, 2014)

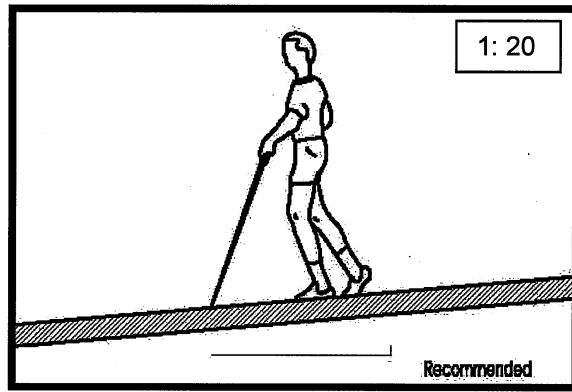

Figure 1.2 Running Slope (Global Alliance on Accessible Technologies and Environments, 2014)

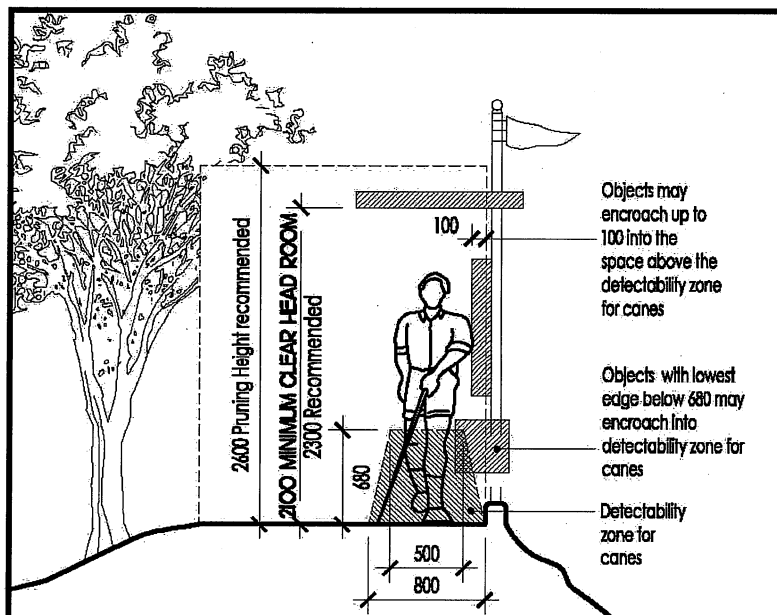

Figure 1.3 Head Clearance (Global Alliance on Accessible Technologies and Environments, 2014)

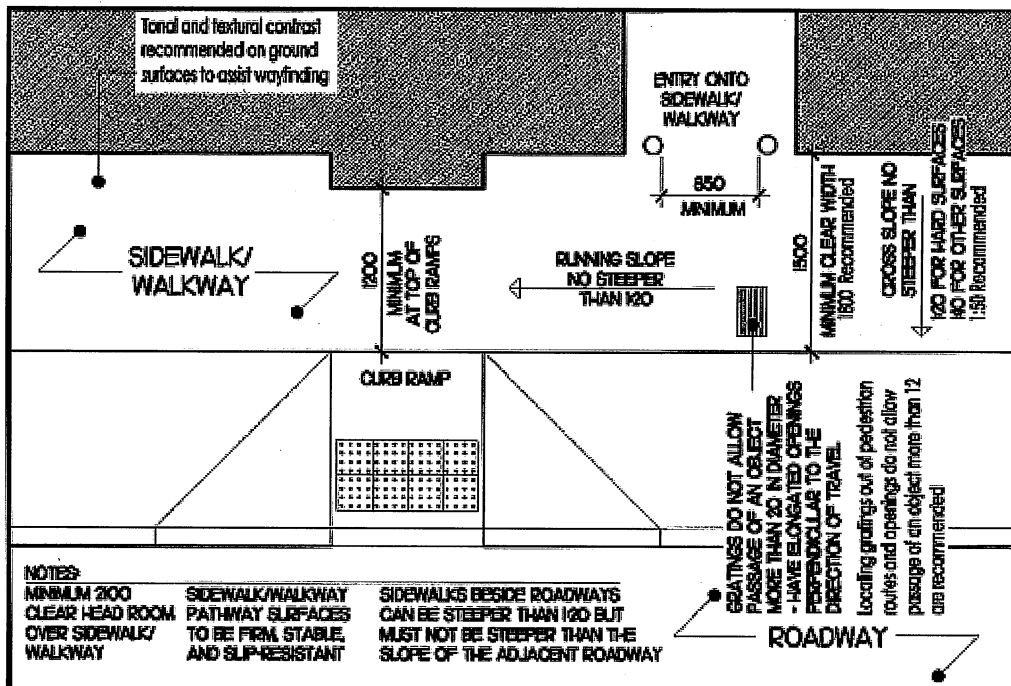

Figure 1.4 Design Requirements for Sidewalks and Walkways (Global Alliance on Accessible Technologies and Environments, 2014)

1.2 Ramps

(Design of Public Spaces Standard, AODA)

Rationale

Ramps can be problematic in providing accessibility, as they can be difficult and dangerous to navigate. Also, the physical space required for ramps makes them cumbersome to integrate into a facility. The design of the ramp is critical to its usefulness and safety. Ramps should not be too steep and provide enough turning space for:

- Users of mobility aids
- Caregivers with strollers
- Visitors with luggage

Application

Any part of an accessible route with a slope steeper than 1:25 shall be considered a ramp and shall comply with this section.

NOTE:

Where a ramp is being proposed to ensure barrier-free access to a building entrance, the Ontario Building Code and this guideline may deal with the same matter. In these instances, it is acknowledged that the Ontario Building Code represents the applicable law and in certain circumstances will represent the minimum standards for accessibility.

The following design requirements are guidelines that will be applied during the review and approval of a site plan. Where it is not reasonably feasible to meet the design requirements, the site plan must comply with the barrier-free standards established in the Ontario Building Code.

Design Requirements

Organizations must comply with the ramp requirements in this section when installing them on exterior paths of travel, but not for ramps connected to a building. *All aspects of a ramp must meet the following requirements:*

Ramps:

- Must have a minimum clear width of 900 mm;
- Must have a maximum running slope of 1:15;
- Must be provided with landings (see page 16);
- Must be provided with handrails (see page 16 and 17);
- Surface must be firm, stable, and slip resistant;
- Outdoor ramps and their approaches shall be designed so that water will not accumulate on walking surfaces;
- Edges of ramps and landings shall be protected with a wall or guard on all sides;
 - Where a guard is provided, it must be no less than 1,070 mm measured vertically to the top of the guard from the ramp surface;
 - Be designed so that no member, attachment, or opening located between 140 mm and 900 mm above the ramp surface being protected by the guard, will facilitate climbing
- Edge protection must be provided;
 - With a curb at least 50 mm high on any side of the ramp where no solid enclosure or solid guard is provided;
 - With railings or other barriers that extend to within 50 mm of the finished ramp surface

Landings (Refer to Figure 1.5):

- Required at the top and bottom of ramp;
 - Must be a minimum size of 1,670 mm by 1,670 mm
- Required every 9 m on long in-line ramps;
 - Must be a minimum size of 1,670 mm in length and the same width of the ramp itself
- Required when there is an abrupt change in direction of the ramp
- Maximum running slope ratio must be 1:15;
- Maximum cross slope of a landing is 1:50;
- The intermediate landing at the switchback of a U-shaped ramp shall have a length not less than 1,670 mm and a width not less than 2,440 mm. In a retrofit situation where creating a suitably sized landing is technically infeasible, the required landing width may be reduced to 2,120 mm;
- The intermediate landing at the corner of an L-shaped ramp shall have a length and width not less than 1,670 mm;
- The intermediate landing at an in-line ramp shall have a length not less than 1,670 mm

Handrails (See Figures 1.5, 1.6 & 1.7):

- Must be provided where the ramp run has a rise greater than 150 mm;
- Are continuously graspable and on both sides;
 - Have circular cross-section with an outside diameter not less than 30 mm and not more than 40 mm
 - Any non-circular shape with a graspable portion that has a perimeter not less than 100 mm and not more than 155 mm and whose largest cross-sectional dimension is not more than 57 mm
- Must be between 865 mm and 965 mm in height;
- Extend horizontally no less than 300 mm beyond the top and bottom of the ramp;
- Where the ramp is more than 2,200 mm in width,
 - Organizations must provide one or more additional handrails so that a person using a mobility device has access to a handrail on either side
 - Located so that there is no more than 1,650 mm between handrails
- Be provided with a clearance of 50 mm between the handrail and attached wall
- Are continuous on the inside of switchback (U-shaped) or L-shaped ramps extend horizontally at least 300 mm (11-3/4 in.) beyond the top and bottom of the ramp and return to the wall, door, or post

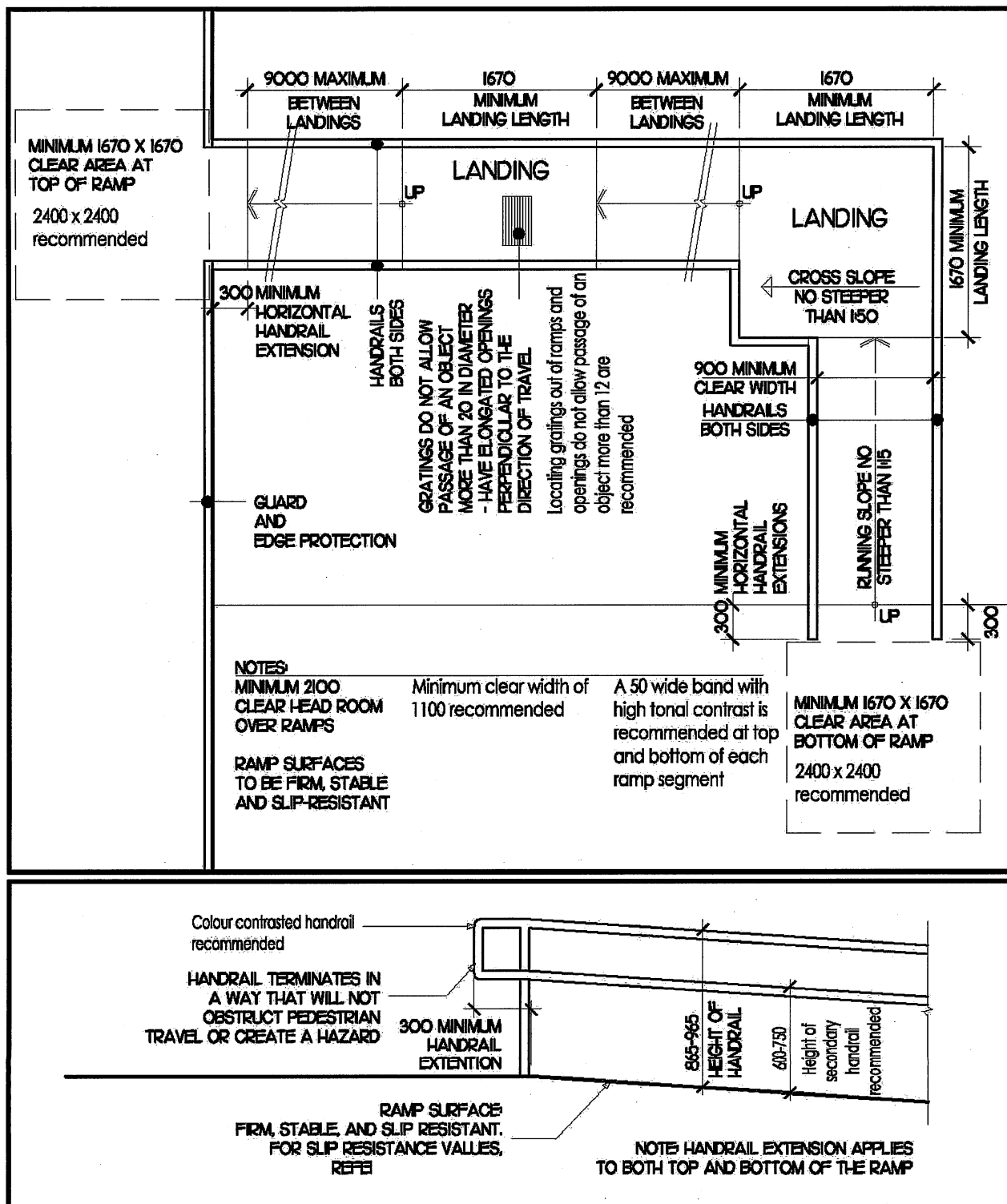

Figure 1.5 Ramp Criteria- Ramp, Landing and Handrail (Global Alliance on Accessible Technologies and Environments, 2014)

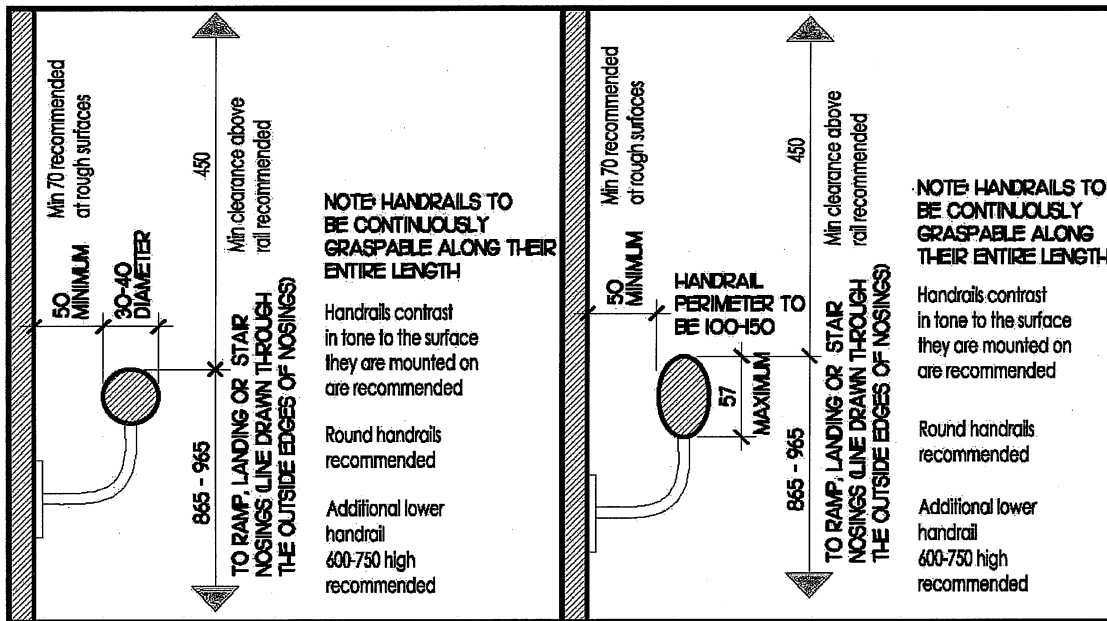

Figure 1.6 Handrail Dimensions (Global Alliance on Accessible Technologies and Environments, 2014)

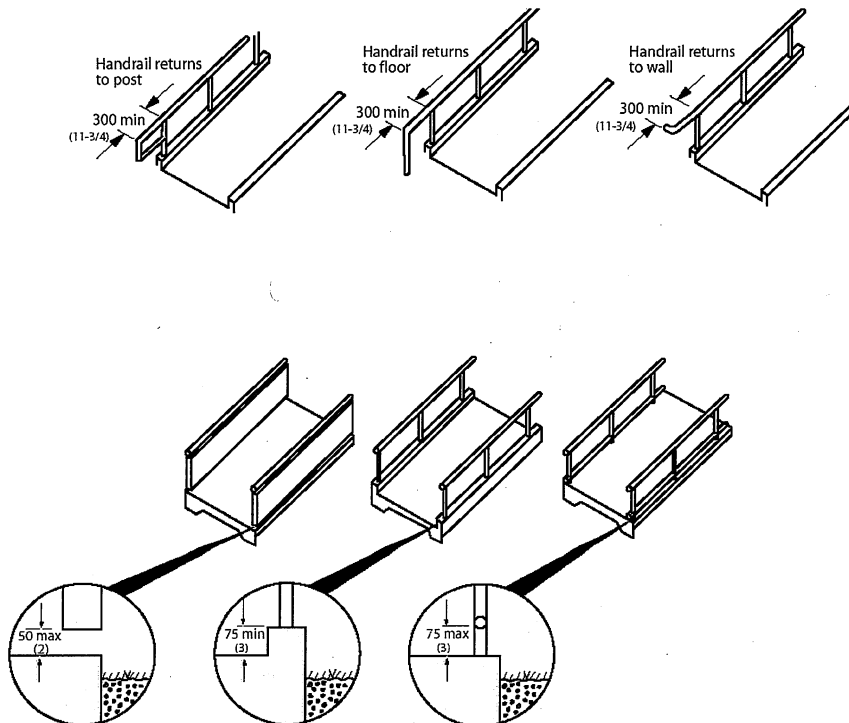

Figure 1.7 Horizontal Handrail Extensions and Edge Protection at Ramps (Facilities Accessibility Design Standards, 2007)

1.3 Curb Ramps

(Design of Public Spaces Standard, AODA)

Rationale

The design of curb ramps is very important in the interest of moving people safely and efficiently off public pedestrian routes. While a smooth transition and minimal slope are ideal for someone in a wheelchair, they are a potential hazard to an individual with a visual impairment who may not notice the transition from sidewalk to street. Textured surfaces become an important safety feature in this scenario.

Application

Curb ramps complying with this section shall be provided wherever any path of travel crosses a curb.

Design Requirements

Where a curb ramp is provided on an exterior path of travel, the curb ramp must align with the direction of travel and meet the following requirements:

- Minimum width of 1,500 mm, exclusive of flared sides, except where the Alternate Ramp Curb configuration is used, where the minimum width at the top of the ramp may be reduced to 1220 mm (48 in.) (Refer to Figure 1.8, 1.10).
- Minimum width of 1,200 mm, exclusive of any flared sides;
- Maximum cross slope of the curb ramp is 1:50 (2%);
- Maximum slope on the flared side of the curb must be no more than 1:10;
- The running slope of the curb ramp must:
 - o Be a maximum of 1:8, where elevation is less than 75 mm;
 - o Be a maximum of 1:10, where elevation is 75 mm or greater and 200 mm or less
- Where the curb ramp is located at a pedestrian crossing it must:
 - o Have raised tactile profiles (See Figure 1.9);
 - o Have a high tonal contrast with the adjacent surface;
 - o Be located at the bottom of the curb ramp;
 - o Be set back between 150 mm and 200 mm from the curb's edge;
 - o Extend the full width of the curb ramp;
 - o Be a minimum of 610 mm in depth.
- Curb ramps provided adjacent to the barrier-free entrance shall be designed and constructed in accordance with the minimum standards established in the Ontario Building Code.

Curb ramp configuration shall be:

- The maximum cross fall of gutters and road surfaces immediately adjacent to curb ramps shall be 1:20.

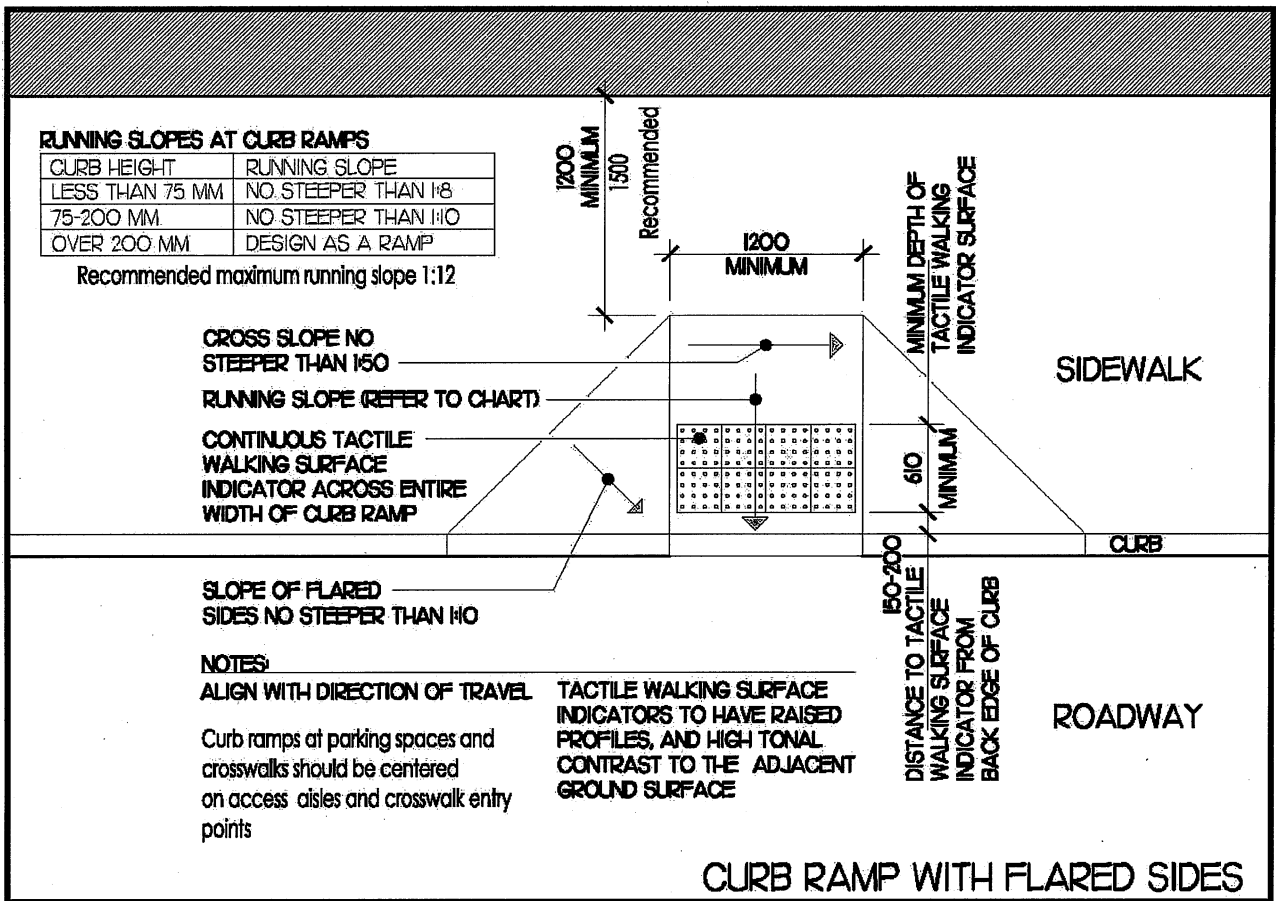

Figure 1.8 Standard Curb Ramp with Flared Sides (Global Alliance on Accessible Technologies and Environments, 2014)

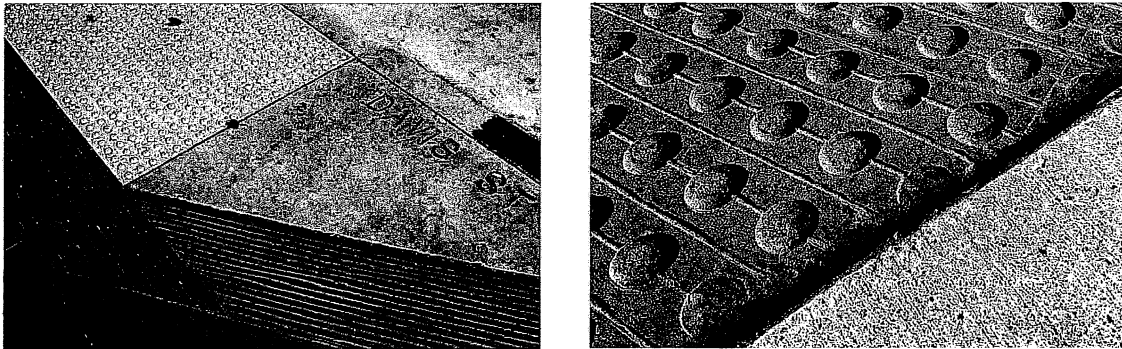

Figure 1.9 Examples of Tonal Contrast Tactile Walking Surface Indicators (Global Alliance on Accessible Technologies and Environments, 2014)

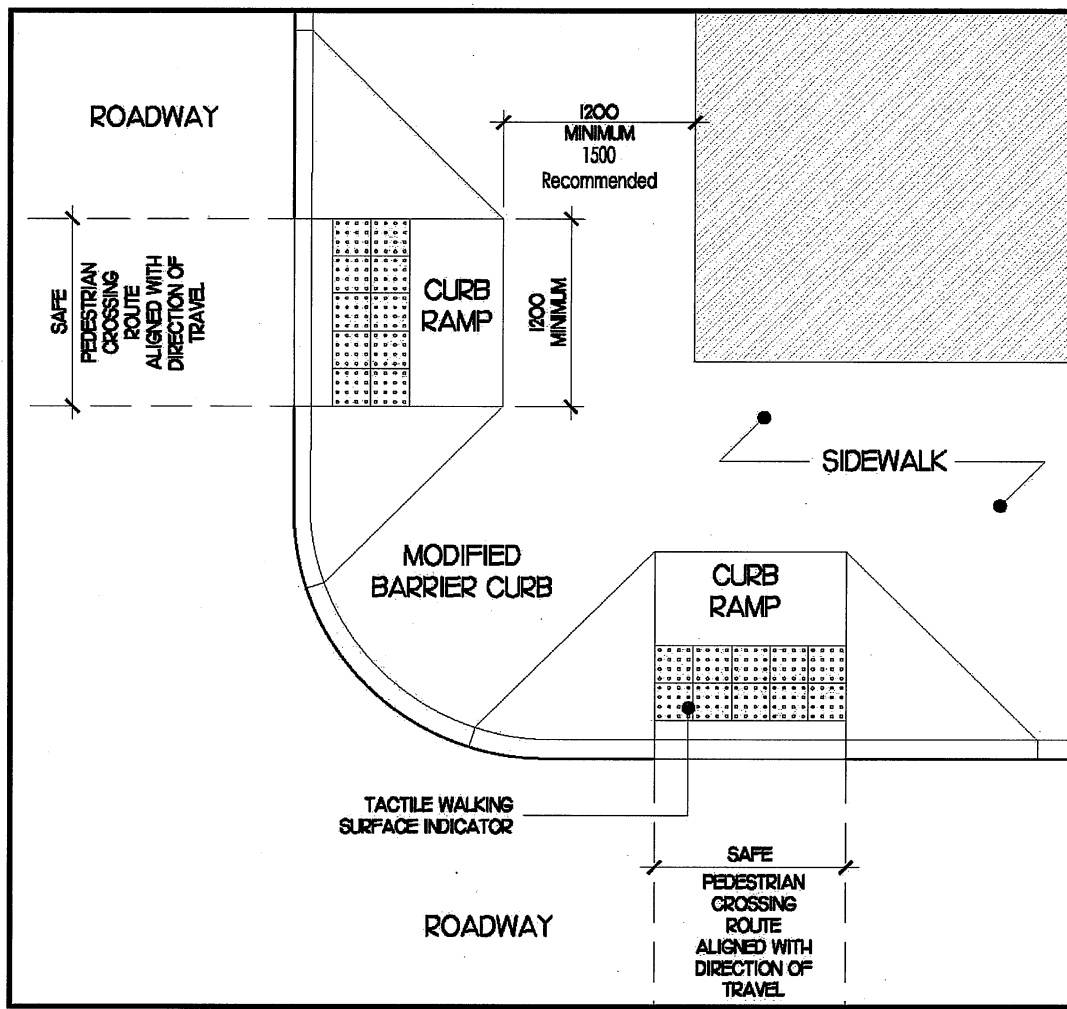

Figure 1.10 Corner Curb Ramps (Global Alliance on Accessible Technologies and Environments, 2014)

1.4 Stairs

(Design of Public Spaces Standard, AODA)

Rationale

The requirements for stairs will improve safety and accessibility for all stair users. Many people with disabilities do not use wheeled mobility devices. Falls on stairs are a major threat to a person's health, independence, and confidence. However, stairs are a barrier for people who do use mobility devices. It is recommended that stairs only be used as an alternate way of negotiating level changes where barrier-free access is already provided.

Application

Similar to ramps, organizations must meet the requirements outlined in this section when installing stairs where they connect to an exterior path of travel, but not for stairs that are connected to a building.

Organizations may consider installing stairs beside a sloped walkway or ramp. People with limited stamina may prefer to climb a short flight of stairs rather than take a longer, gradual inclined route. Stairs are, as previously mentioned, a barrier for many forms of disability, and therefore should not be the only way of changing levels on an exterior path of travel.

Design Requirements

Exterior path of travel stairs shall meet the following requirements (See Figures 1.11):

- Tread surface must be slip resistant;
- Risers and runs must be uniform in height per one flight;
- The rise between treads must be within the range of 125 mm and 180 mm;
- The run between treads must be within the range of 280 mm and 355 mm;
- Stairs must have closed risers;
- The maximum nosing projection on a tread must be no more than 38 mm, with no abrupt undersides;
- Must have high tonal contrast markings that extend the full tread width of the leading edge of each step;
- Must be equipped with tactile surface indicators that are built in or applied to the surface;
 - Have raised tactile profiles;
 - Have high tonal contrast with the adjacent surface;
 - Be located at the top of a flights of stairs; and
 - Extend the full tread width to a minimum depth of 610 mm commencing one tread depth from the edge of the stair.
- Handrails must be included on both sides (see pages 16 and 17 for more details);
- A guard must be provided where there is no wall;
 - That is not less than 920 mm, measured vertically to the top of the guard from a line drawn through the outside edges of the stair nosings and 1,070 mm around the landings and is required on each side of the stairway where the difference in elevation between ground level and the top stair is greater than 600 mm

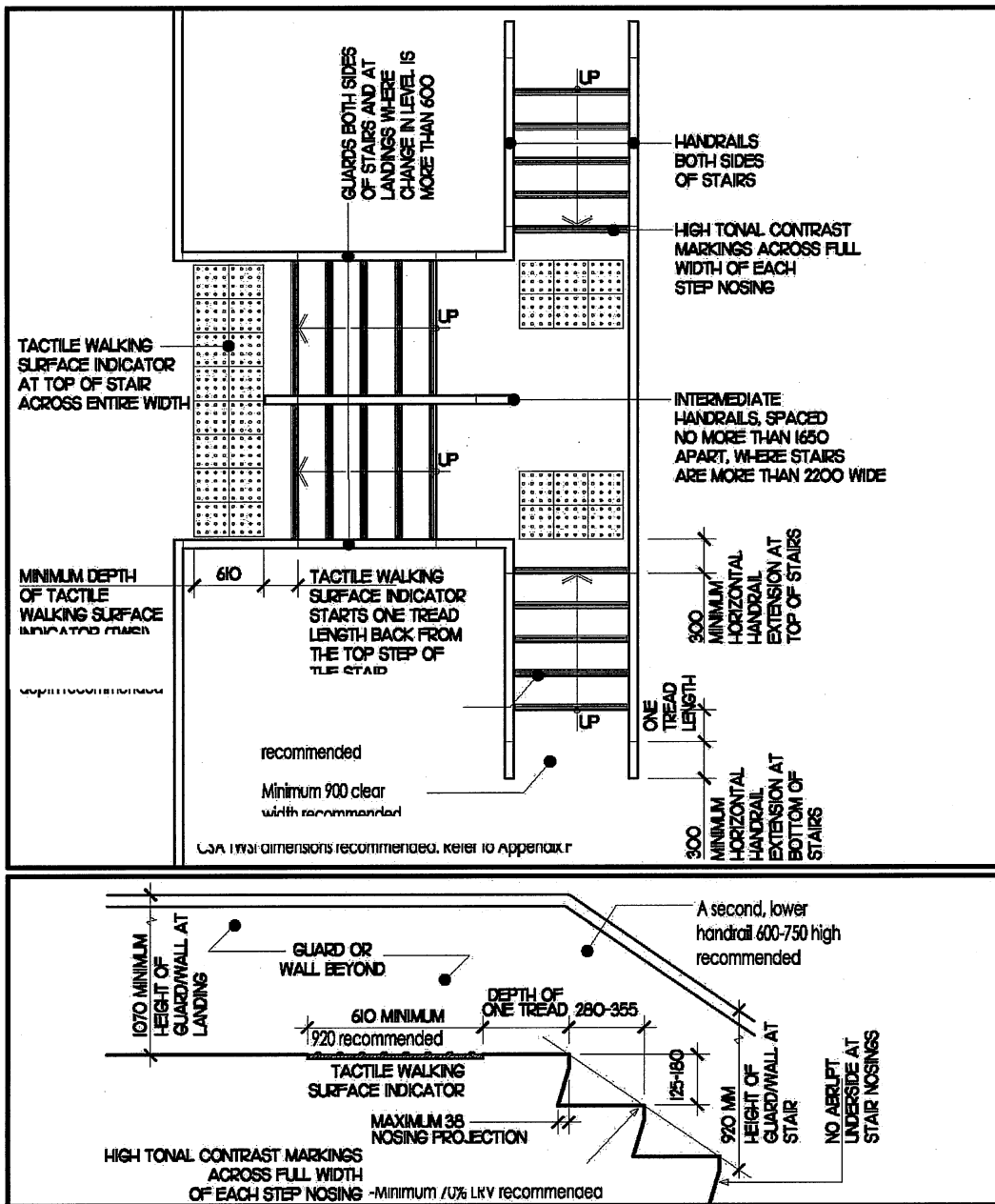

Figure 1.11 Stair Dimensions (Global Alliance on Accessible Technologies and Environments, 2014)

1.5 Off-Street Parking

(Design of Public Spaces Standard, AODA)

Rationale

Ontario's aging population is driving a need for more accessible off-street parking. Statistics Canada and Government of Ontario data project a 4 % increase in the number of accessible parking permit holders by 2025. The intent of province-wide standards is to meet the needs of a diverse and growing population of accessible parking permit holders. Minimizing travel distances is particularly important outdoors, where weather conditions and ground surfaces can make travel both difficult and hazardous for people of various disabilities.

Application

Designated parking spaces shall include accessible parking spaces and "limited mobility & caregivers only" parking spaces. The number of accessible parking spaces required by this section may not be sufficient in some facilities (such as seniors' centres), where increased numbers of persons with disabilities are expected. In which case, the municipality may require an increased number of designated parking spaces.

Designated parking spaces shall be located on the shortest possible accessible route of travel, with minimal traffic flow crossing, to an accessible facility entrance or to an accessible pedestrian entrance of the parking facility.

The accessible parking requirements apply to new parking facilities and the redevelopment of existing parking facilities. For the purposes of this regulation, re-painting of existing lines to mark parking spaces and other periodic maintenance or restorative activities do not trigger redevelopment requirements. The regulation is not intended to discourage general upkeep of parking facilities, but to provide more opportunities to enhance accessibility.

There are two types of accessible parking spaces. Type A spaces are for people who use mobility devices and need more space for the deployment of ramps. Type B spaces are for people who use canes, crutches, or walkers and do not need this extra space. To know what proportion of Type A and Type B parking spaces to regular parking spaces are required per parking lot see Table 1 and Table 2.

Design Requirements

Type A spaces shall (See Figure 1.13):

- Have a minimum width of 3,400 mm, and signage that identifies the space as "van accessible".
- Minimum head clearance room of 2,100 mm

Type B spaces shall (See Figure 1.14):

- Have a minimum width of 2,400 mm.
- Minimum head clearance room of 2,100 mm

Both Types A and B shall:

- Have a firm, level surface with a maximum of 1.5% running slope for drainage;
- Have a maximum cross slope of 1%;
- Incorporate signage as outlined in this section;
- Share an access aisle.

Types A and B parking spaces shall be designated with signage that is (See Figure 1.12):

- Mounted vertically on a post or on a building, in a location direct proximity to the parking space;
- At least 300 mm (11-3/4 in.) wide x 450 mm (17-3/4 in.) high;
- Installed at a height of 1500 mm (47 in.) to 2500 mm (98 in.) from the ground/floor surface to the centre line of the sign for perpendicular parking, centred on the parking space; and
- Shows the International Symbol of Access.

Location of Parking Spaces

The regulation does not prescribe where an organization should install the two types of accessible parking spaces in relation to each other. For example, an organization may locate Type B spaces closer to an entrance for users of canes, crutches and walkers, who may have limited stamina compared with users of wheeled mobility devices such as scooters. Organizations will make these decisions with input from professionals, such as planners and architects. Design choices should address the unique set of opportunities and challenges of each parking facility.

Access Aisles must meet the following requirements (See Figure 1.15):

- Have a minimum width of 1,500 mm
- Must extend the full length of the parking space
- Must be marked with high tonal contrast diagonal lines, which discourages parking in them, where the surface is asphalt, concrete or some other hard surface;
- Must be marked with additional signage or provide contrasting ground surface treatment, where the surface is unpaved.

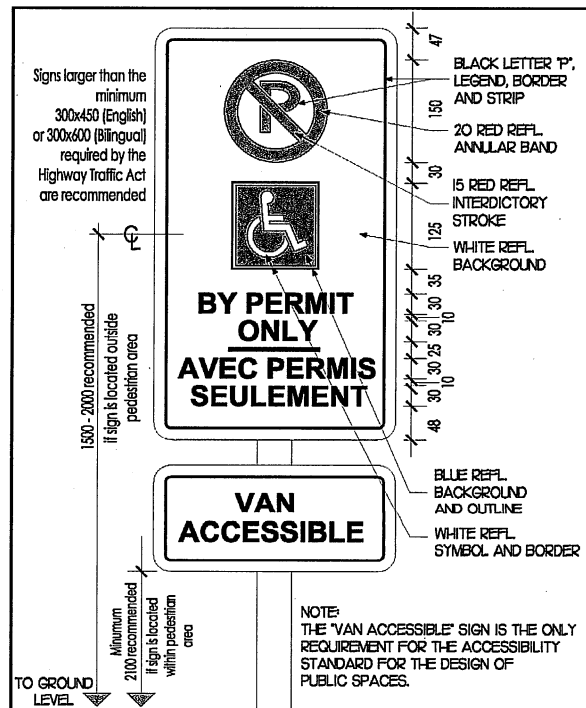

Figure 1.12 Signage Design Requirements (Global Alliance on Accessible Technologies and Environments, 2014)

Table 1 Minimum Number and Type of Accessible Parking Spaces (Government of Ontario, 2014)

Total Number of Parking Spaces in Parking Facility for Public Use	Total Number of Accessible Parking Spaces Required	Type A Parking Spaces	Type B Parking Spaces
1-12	1	1	0
13-100	4%	<ul style="list-style-type: none"> For lots with an even number of accessible parking spaces- provide an equal number of Type A and Type B spaces For lots with an odd number of total accessible parking spaces- provide an equal number of Type A and Type B spaces. The additional space should be a Type B space. 	
101-200	3% + 1		
201-1000	2% + 2		
1001 +	1% + 11		

Table 2 Examples of Accessible Parking Requirements (assuming in odd number cases, Type B is preferred) (Government of Ontario, 2014)

Total Number of Parking Spaces in Parking Facility for Public Use	Total Number of Accessible Parking Spaces Required	Type A Spaces	Type B Spaces
1	1	1	0
25	1	1	0
75	3	1	2
150	6	3	3
200	7	3	4
500	12	6	6
750	17	8	9
1000	22	11	11

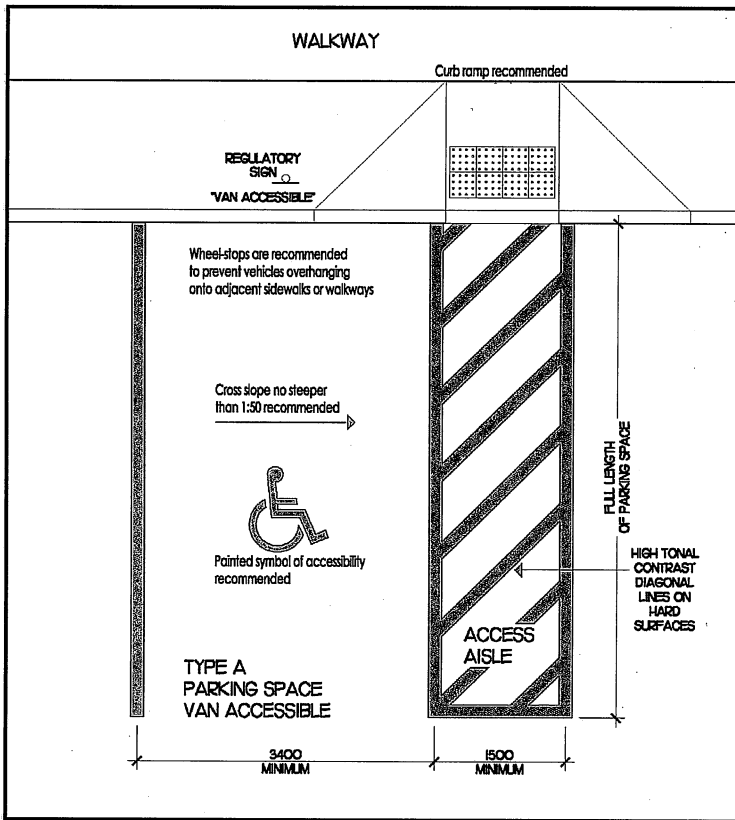

Figure 1.13 Type A Parking Space with Access Aisle (Global Alliance on Accessible Technologies and Environments, 2014)

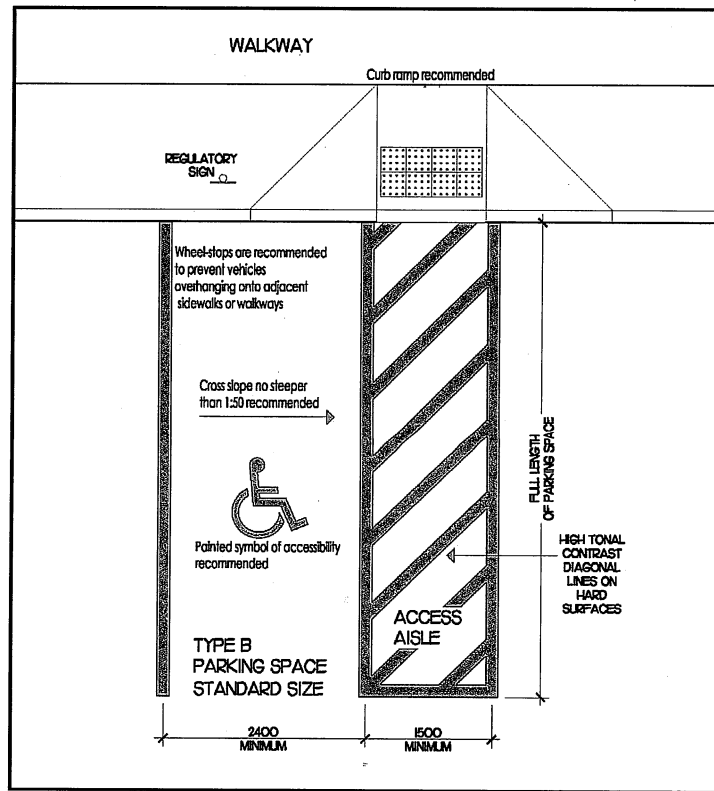

Figure 1.14 Type B Parking Space with Access Aisle (Global Alliance on Accessible Technologies and Environments, 2014)

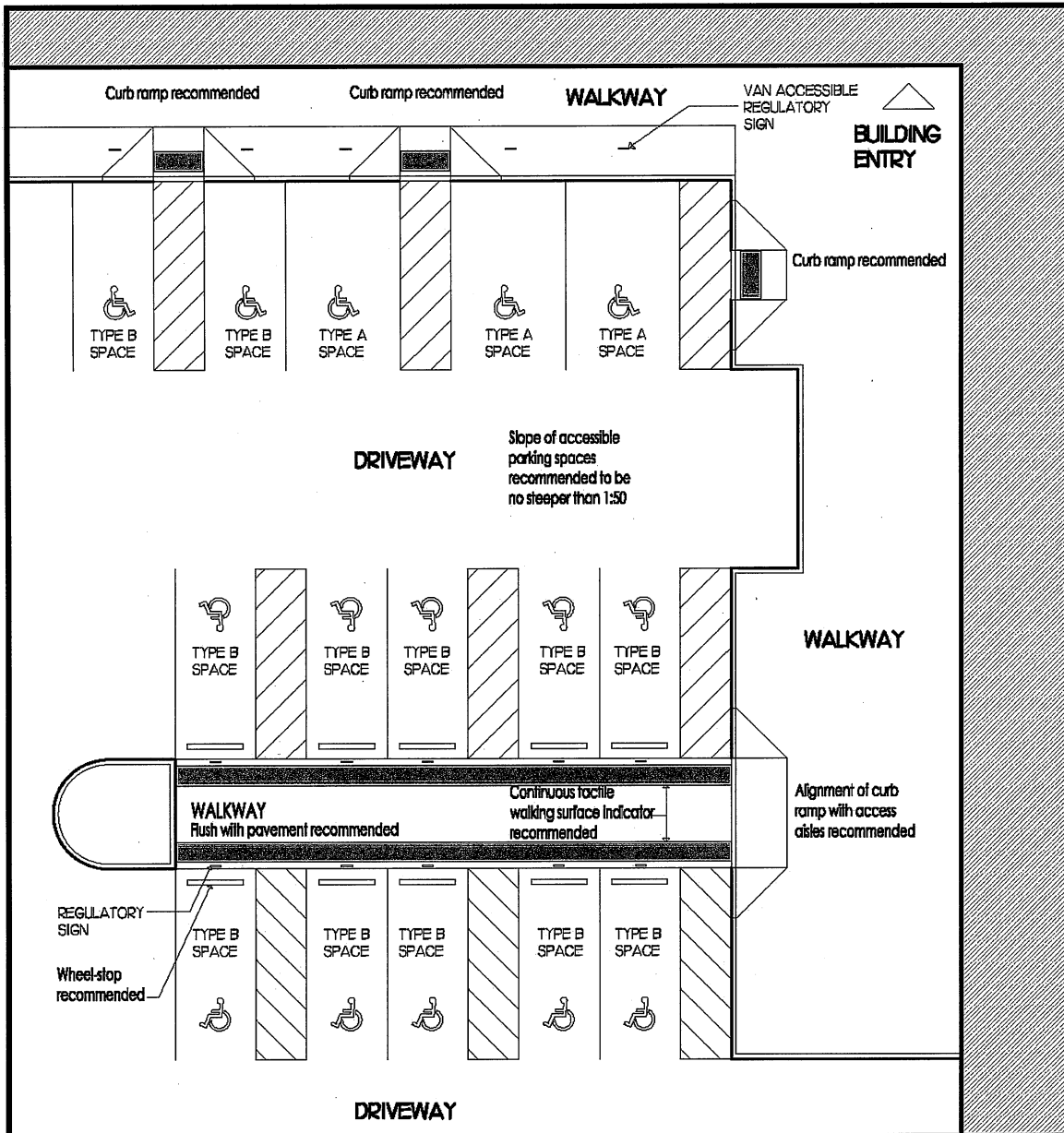

Figure 1.15 Design Criteria for Access Aisles (Global Alliance on Accessible Technologies and Environments, 2014)

1.6 Passenger Loading Zones

(London FADS)

Rationale

Passenger-loading zones are important features for individuals who may have difficulty in walking distances. Accessible transit vehicles typically require space for the deployment of lifts or ramps and overhead clearances. Protection from the elements will be beneficial to all users and particularly those that may have difficulty with mobility.

Application

Where passenger-loading zones are provided, at least one shall comply with this section. Accessible passenger-loading zones shall be identified with signage

Design Requirements

Passenger-loading zones shall (See Figure 1.16):

- Be on an accessible route;
- Provide an access aisle at least 2440 mm wide and 7000 mm long, adjacent and parallel to the vehicle pull up space. In a retrofit situation where providing a 2440 mm wide access aisle is technically infeasible, the access aisle width may be reduced to 2000 mm;
- Have an accessible curb ramp where there are curbs between the access aisle and the vehicle pull-up space;
- Have a minimum vertical clearance of 3350 mm at the loading zone and along the vehicle access route to such areas to and from the facility entrances.

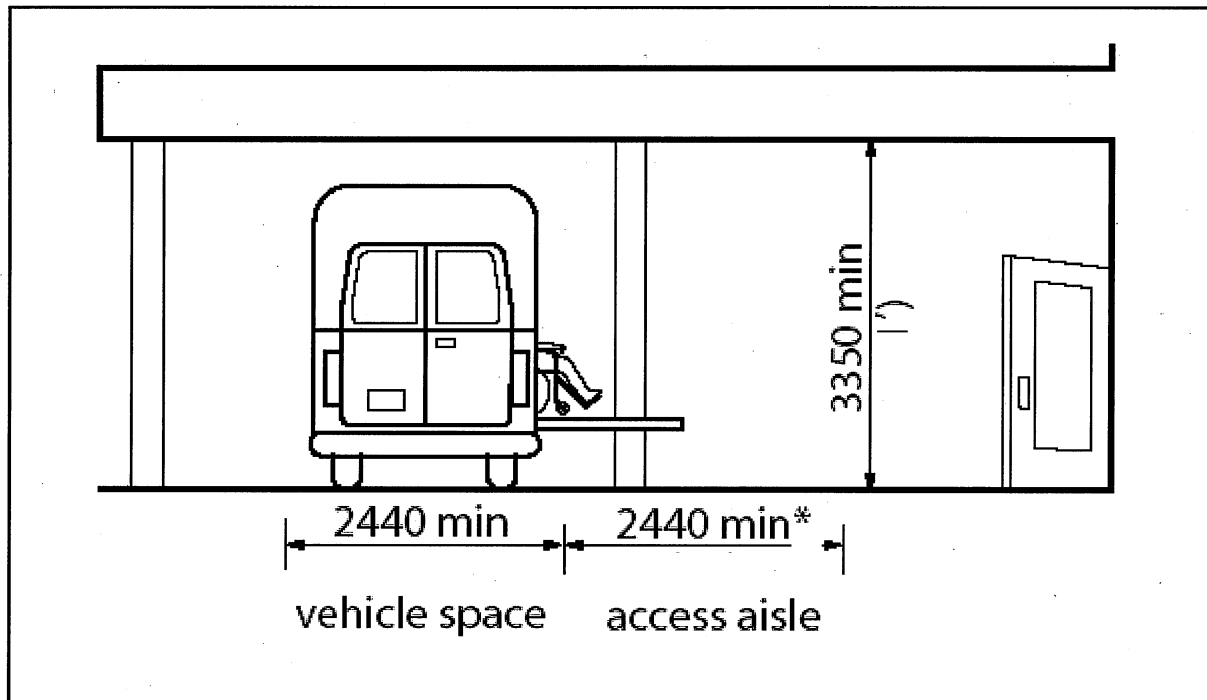

Figure 1.16 Clearances at Passenger Loading Zones (Facilities Accessibility Design Standards, 2007)

1.7 Landscaping Materials and Plantings

(London FADS)

Rationale

Landscape materials, trees, shrubs and plants should be selected and located with a wide variety of users in mind. For instance, plants and shrubs with a variety of fragrances can provide an interesting orientation cue for persons with a visual impairment. Using contrasting flowers near walkways can also be helpful as a guide. Plants with thorns may constitute a walking hazard.

Plants that drop large seed pods can present slipping hazards, as well as difficulties for pushing a wheelchair. Plantings and tree limbs that overhang pathways can impede all users and be a particular hazard to an individual with a visual impairment. Raised beds can better accommodate persons who use a mobility device or those that have difficulty in bending to enjoy or tend to plantings. The use of unit pavers as a walking/wheeling surface is not recommended, unless they are laid in a location that is not subject to the effects of settlement and frost heave, such as over a structural slab or indoors.

Design Requirements

Accessible plant beds shall:

- Be raised 460 mm above the adjacent floor or ground surface;
- Be located on an accessible route;
- The edges of planting beds located immediately adjacent to pedestrian walks, shall incorporate clearly defined, cane-detectable curbs at least 75 mm high;
- Shrubs with thorns and sharp edges shall be planted away from accessible pathways and seating areas. Plants that drop large seed pods shall not overhang or be positioned near accessible paths or walkways;
- Overhanging branches of trees or shrubs over walkways or paths shall not reduce the available headroom at any part of the walkway or path.

1.8 Street Furniture

(London FADS)

Rationale

Street furniture can provide a resting place for any individual with difficulty walking distances. Such furniture should incorporate strong colour contrasts and be located off pathways, to minimize its potential as an obstruction to pedestrians.

Application

All waste receptacles shall be accessible to persons using wheelchairs or other mobility devices.

Design Requirements

Street furniture:

- Shall not reduce the required width of an accessible route;
- Shall be able to be detected with a cane;
- Shall be located to one side of the normal path of pedestrian travel;
- Street furniture shall incorporate pronounced colour contrast to differentiate it from the surrounding environment;
- Must be securely mounted.

Waste Receptacles:

- Shall be large enough to contain the anticipated amount of waste, so that overflows do not cause a tripping hazard;

- Shall be located in accessible open areas shall be mounted on firm, level pads;
- Where lids or openings are provided on waste receptacles, they shall be mounted no higher than 1060 mm above the adjacent floor or ground surface;
- An exterior waste receptacle shall be provided close to each accessible public entrance.

1.9 Lighting, Texture & Colour, Materials & Finishes

(London FADS)

Rationale

Artificial lighting and natural light sources should provide evenly distributed light at all areas of potential hazard, indoors and outdoors. The ability of an individual with a visual impairment to navigate an environment can be enhanced through the strategic use of colour and texture. The selection of flooring materials can be critical to the safe and easy movement of persons using all kinds of mobility aids, as well as persons with low vision.

Application

Exterior lighting systems, materials and textural and colour systems shall be used to enhance accessibility and shall comply with this section.

Design Requirements

Lighting:

- Shall provide a good colour spectrum;
- Shall be evenly distributed to minimize cast shadows;
- Shall minimize direct or indirect glare on nearby reflective surfaces;
- Required at the following locations: steps, stairs, pedestrian entrances, pedestrian routes, parking spaces.

Materials and Finishes:

- Steps shall be finished with a non-slip material and incorporate highly contrasted nosing;
- Ramp surfaces shall be firm and non-slip;
- Hard, monolithic materials shall be non-slip and non-glare;
- Wall surfaces shall be non-abrasive.

Texture and Colour:

- Colours in the warm end of the spectrum (yellow, orange, red), are easier to recognize than cool colours;
- Contrast colour shall define edges or boundaries of objects, doors, stair nosing, walls;
- Flooring materials and textures shall enhance wayfinding;
- For signs, the most visible colours are white or yellow on a black or other dark background, black lettering on a white background is also acceptable.

Bibliography

Accessibility for Ontarians with Disabilities Act. (2005).

Facilities Accessibility Design Standards. (2007). City of London.

Global Alliance on Accessible Technologies and Environments. (2014). *The Illustrated Technical Guide to the Accessibility Standard for the Design of Public Spaces.* Retrieved from <http://www.gaates.org/DOPS/default.php>

Government of Ontario. (2014). *Integrated Accessibility Standards Regulation Guidelines- Design of Public Spaces Standard.*

Integrated Accessibility Standards; Ontario Regulation 191/11

Ontario Planning Act. (2014). Canada Law Book.

Statistics Canada, C. (2006). *Community Profiles.*

Statistics Canada, C. (2012). *Adults with and without disabilities, by age group and sex, Canada, provinces and territories.*

Statistics Canada, N. (2011). *NHS Profile, Huron, CTY, Ontario.*

Section 2 Accessible Design Checklist for Site Plans



Accessible Design Checklist for Site Plans

The Accessible Design Checklist has been created to assist staff in reviewing a site plan control application that has been submitted for approval. The Checklist is a reference tool only and must be used in conjunction with the Huron County Accessibility Guideline for Site Plan Control document.

*NOTE: See the AODA's Integrated Accessibility Standards Regulation Guidelines- Design of Public Spaces Standard publication in full for complete information *

Exterior Paths of Travel

- Entrances used by staff and the public are accessible and are identified with sufficient signage;
- The path has a minimum width of 1,500 mm, has a passing space, edge protection, and appropriate lighting;
- The running slope of the sidewalks do not exceed a ratio of 1:20;
- Pavement markings and directional signage are provided along the exterior path leading from the entrance to designated parking spaces;
- There are no protruding overhead objects, and the headroom is a minimum of 2,100 mm;
- Sidewalk entrances have a clear opening at a minimum of 850 mm;
- The surface material used is firm, stable, and slip resistant.

Ramps

- Have a maximum slope ratio of 1:15;
- Have a minimum clear width of 900 mm
- Edge protection and guards are provided on ramps;
- Landings are provided at top and bottom of the ramp, or at a change in direction, and meet required dimensions;
- Are equipped with handrails on both sides that are continuously graspable, and meet required dimensions;
- Surface is firm, stable, and slip resistant.

Curb Ramps

- Have a running slope between 1:8 – 1:10;
- Minimum width of 1,200 mm, exclusive of any flared sides;
- Maximum cross slope of the curb ramp is 1:50 (2%);
- Maximum slope on the flared side of the curb must be no more than 1:10;
- Curb ramps have tactile surface indicators;
- The maximum cross fall of gutters and road surfaces immediately adjacent to curb ramps shall be 1:20.

Stairs

- Risers and runs must be uniform in height per one flight;
- The rise between treads must be within the range of 125 mm and 180 mm;

- The run between treads must be within the range of 280 mm and 355 mm;
- Stairs must have closed risers;
- Must be equipped with tactile surface indicators that are built in or applied to the surface;
- Handrails and a guard must be provided.

Parking

- Parking spaces are located such that persons do not travel behind parked cars, nor across a drive aisle;
- Type A and B accessible parking spaces are provided in sufficient number and have required dimensions and adjacent curb cuts;
- Accessible parking spaces are identified by vertical signage and pavement markings;
- Pavement markings and directional signage are provided along the accessible route leading from the entrance to designated parking spaces;
- Passenger loading zone is located adjacent to an access aisle and has required dimensions.

Landscaping

- A 36" clearance is provided between plantings with thorns and pathways/seating areas;
- Cane-detectable curbs are provided at plantings & grade changes next to pedestrian walks.

Street furniture

- Waste receptacles, light standards, signs, planters, mail boxes are designed to be accessible and do not reduce required width of routes.

Lighting

- Entrances, routes, walkways, parking areas and passenger drop-off area are adequately light.

Texture & Colour

- Exterior Stairs have a non-slip finish & highly contrasting nosing;
- Detectable warning surfaces cane-detectable and differentiated;
- Detectable warning surfaces are provided on exterior walkways, curb ramps, stairs, platforms;
- Consistent use of texture & colour throughout the site to identify same hazards.
- Yellow and white on black background are the most visible colours to provide contrast for people with visual impairments.